

# SZG113 series of high power led high bay light



## Applications:

- plant, workshop, warehouse, etc.
- coal shed, cargo shed, logistics center, etc.
- convention and exhibition centre
- exhibition hall
- reception hall
- terminal waiting hall
- indoor sports venues

## Descriptions of performance:

brand of led chip	luminous efficiency of led	light efficacy of luminaire	brand of led driver	wide input voltage	power efficiency
PHILIPS	230 lm/W	180 lm/W	ZH power	90~305 Vac	≥94%
power factor	total harmonic distortion	surge lightning protection	beam angle	shell material	IP protection
≥0.95	≤10%	6000 KV	60° /90° / 120°	ADC12 die-cast aluminum	IP66

## Product profile:

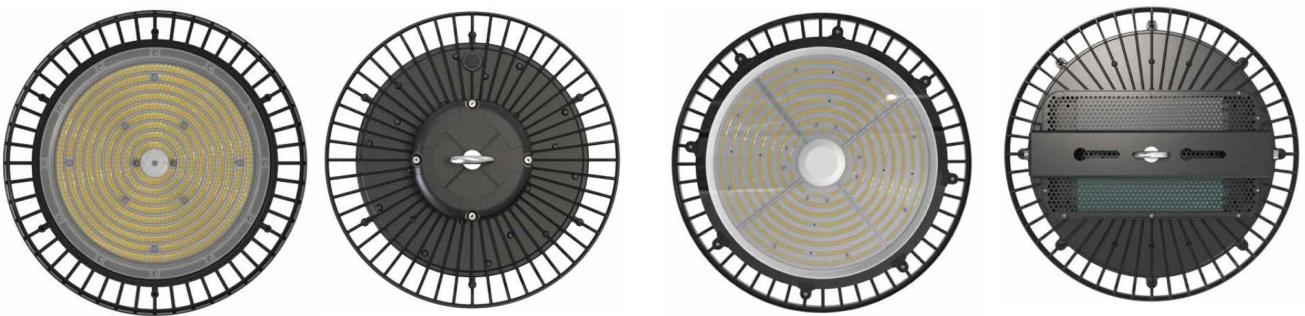

300W (Circular power supply/bar power supply)

500W (Circular power supply/bar power supply)

### Product sizes:

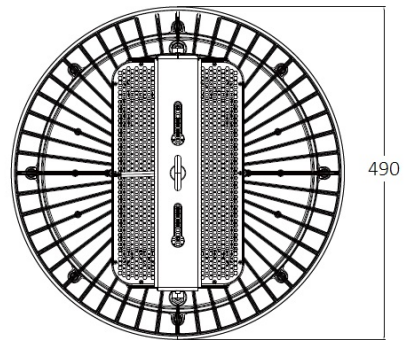
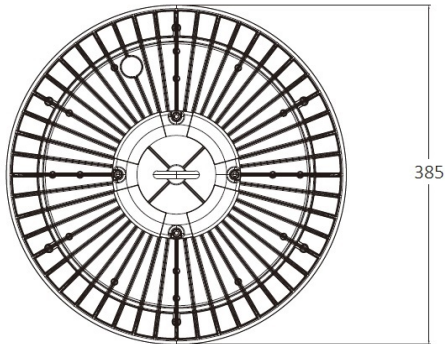
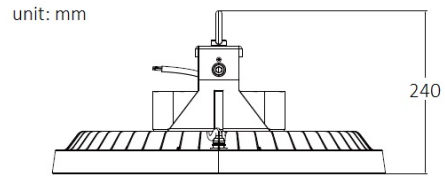
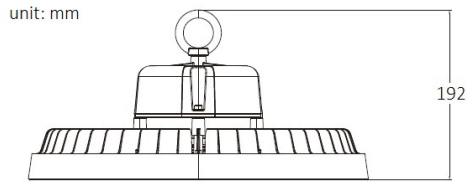

size of 300W

size of 500W

### Picture of explode product:

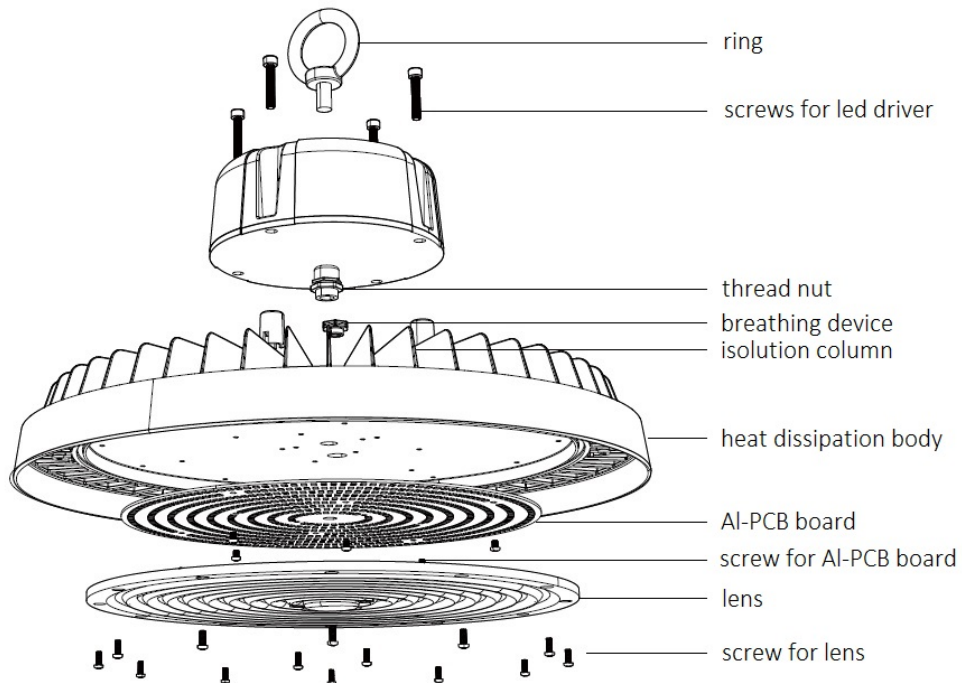

## Technical parameters:

Parameter items	300W	500W
Input voltage (V)	90-305Vac	90-305Vac
Power efficiency	≥94%	≥94%
Power factor	≥0.95	≥0.95
Surge lightning protection (V)	6000	6000
Total harmonic distortion	≤10%	≤10%
Quantity of led chip (pcs)	480	1400
Luminous efficiency for led (lm/W)	220	230
Total luminous flux (lm)	66,000±5%	115,000±5%
Light efficacy for luminaire (lm/W)	170	180
Correlated color temperature (K)	3000-6500	3000-6500
Color rendering index (Ra)	≥75	≥75
Beam angle (°)	60° /90° / 120°	60° /90° / 120°
LED lifespan (h)	≥100,000	≥100,000
Working temperature (°C)	-40~+50°C	-40~+50°C
IP protection	IP66	IP66
IK protection	IK08	IK08
Installation mode of led driver	external	external
Dimensions (mm)	φ 385*192	φ 490*240
Weight (Kg)	4.0	5.5
Mounting mode	Ring/U-bracket	Ring/U-bracket
Warranty	5 year	5 year

**Note:** reflector optional

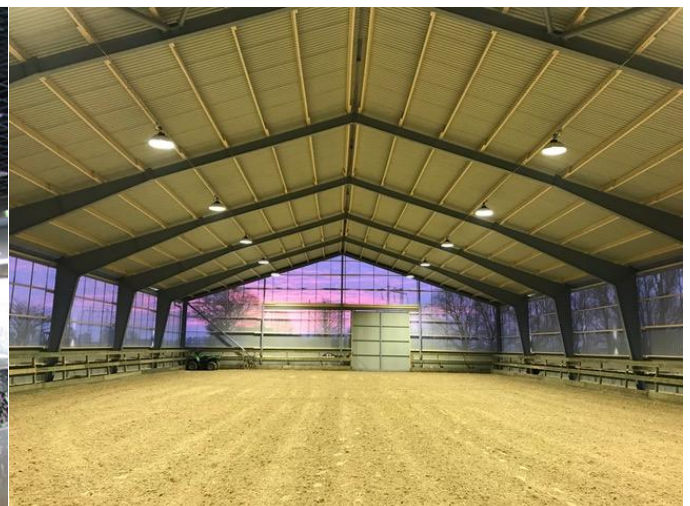

## Test report of luminous efficiency of led chip:

EVERFINE 远方

Test report

EVERFINE LEDspec Test Report

4 Of 4

### Spectrum Test Report

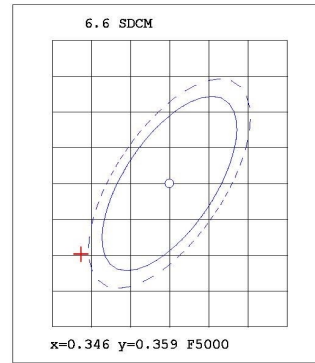
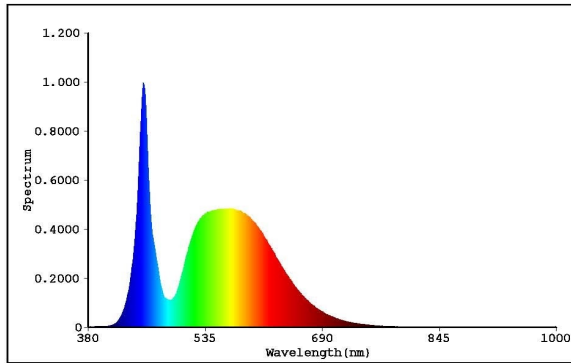

#### Color Parameters:

Chromaticity Coordinate(2Deg): $x=0.3347$   $y=0.3492$ / $u'=0.2053$   $v'=0.4819$   $duv=3.134e-003$

Tc=5410K Dominant WL:Ld=558.0nm Purity=5.2%

Ratio:R=14.0% G=82.2% B=3.8% Peak WL:Lp=453.1nm HWL:17.2nm

Render Index:Ra=75.9

R1 =73.76 R2 =81.05 R3 =84.21 R4 =75.46 R5 =73.73

R6 =72.76 R7 =84.81 R8 =61.67 R9 =-15.45 R10=52.76

R11=71.59 R12=42.32 R13=75.35 R14=90.99 R15=69.42

TM30 Parameters: Rf = 74.3, Rg:93.3

#### Photo Parameters:

Flux = 50.96 lm Eff. : 241.29 lm/W Fe = 153.5 mW

#### Electrical parameters:

VF = 5.294 V IF = 39.90 mA P = 211.2 mW Ch1

LEVEL:\*\*[OUT] WHITE:ANSI\_5700K

Status: T=201.00ms Ip=26653 (41%) [ HAAS1200\_V1\_USB ] V2.00.288

Model:40MA  
Tester:D.U.01.0151 24V  
Temperature:25.3Deg  
Manufactory:EVERFINE  
Assessor:damin  
System:WY + HAAS1200\_V1\_USB

Number:5  
Date:2021-06-05 16-41  
Humidity:65.0%  
Remarks:---